

**MP / A / E / G, Green Series**

**Features**

- Wire lug or pC terminals
- Customer selected actuator cap size and color on MPA series
- MPE series sealed to IP65
- Entire series with epoxy sealed terminals
- Actuator guards, decorative hardware, and silicone boot seals available



**Typical performance characteristics**

Contact configuration . . . . . SPDT, DPDT, 3PDT, 4PDT  
 Contact timing . . . . . Break-Before-Make  
 Contact rating max. . . . . 6 A @ 125 VAC, 3 A @ 250 VAC  
 Electrical life . . . . . push on/push off: 30,000 cycles  
 . . . . . momentary: . 20,000 cycles  
 Contact resistance, initial. . . . . 10 mOhms max.  
 Insulation resistance . . . . . 1,000 MOhms min.  
 Dielectric strength. . . . . 1,500Volts rms @ sea level  
 Actuation force . . . . . 4 to 20 N (400 to 2000 gf)  
 Actuator travel . . . . . 3.55 mm

**Environmental specification**

Operating temperature . . . . . -20°C to +80°C  
 Storage temperature . . . . . -40°C to +80°C  
 Solder heat resistance . . . . . wave solder capable to 265°C  
 Seal . . . . . mpe switches IP65

**Material specifications**

Contacts . . . . . copper alloy silver clad  
 Actuator . . . . . brass nickel plated  
 Terminals . . . . . copper alloy gold plated  
 Case . . . . . alkyd polyester (green)UL94 V-O  
 Frame. . . . . stainless steel  
 RoHS Directive 2002/95/EC . . . . . compliant

Pushbutton Switches

<b>Product key</b>		Typical product key					<b>MP</b>	<b>A</b>	<b>1</b>	<b>06</b>	<b>D</b>	<b>04</b>
<b>Type</b>	MP Green Series Pushbutton Switches, panel mount											
<b>Bushing style</b>	A 1/4-40 3.4mm actuator E 1/4-40 3.4mm actuator with 'O' rings G 15/32-32 large actuator											
<b>Number of poles</b>	1 single pole		3 3 poles									
	2 double pole		4 4 poles									
<b>Rating</b>	06 6 Amp											
<b>Function</b>	D 1 & 3 pole push-on/push-off momentary				N 2 & 4 pole push-on/push-off momentary							
	F momentary				R momentary							
<b>Terminals</b>	blank wire lug		PC printed circuit board									
<b>Material</b>	04 RoHS compliant											

**MP / A / E / G, Green Series (Continued)**

Bushing style A

single & double pole



MPA106D



MPA206N

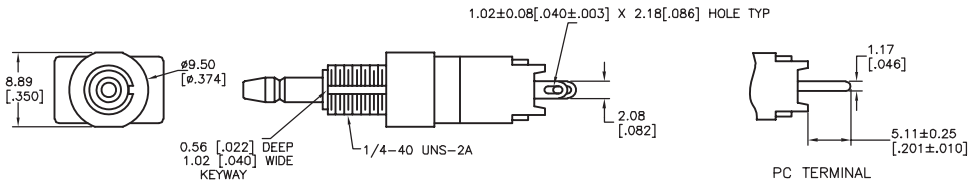
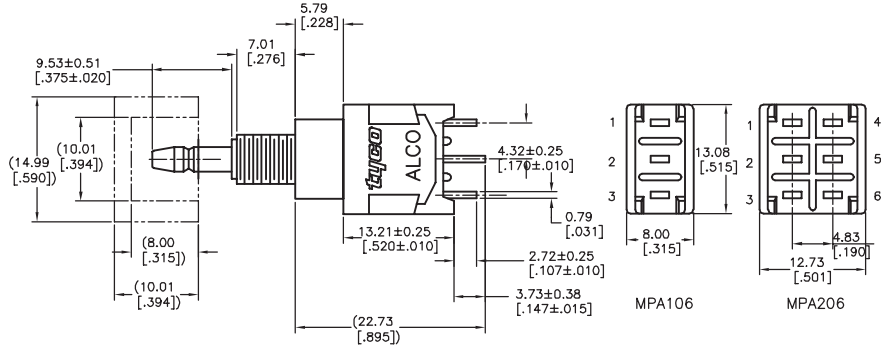

3 & 4 pole



MPA306D



MPA406N

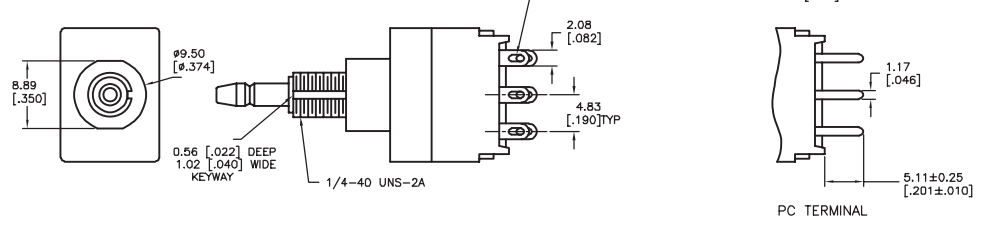
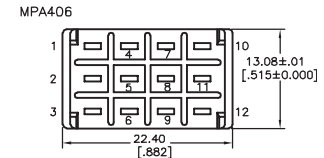
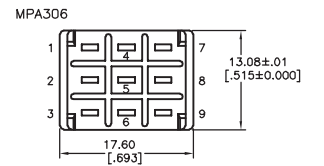
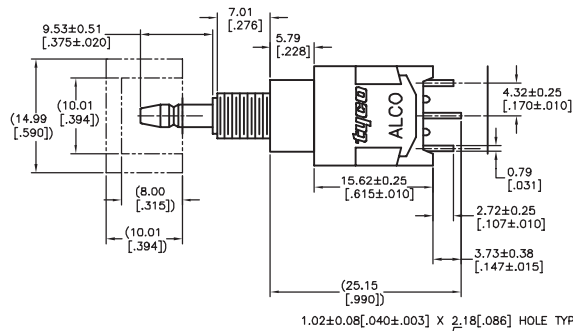

mounting

RECOMMENDED HOLE LAYOUT TO PREVENT ROTATION

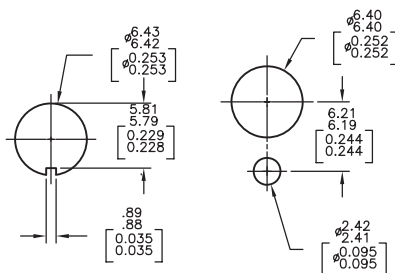

PC BOARD LAYOUT PC TERMINALS ONLY

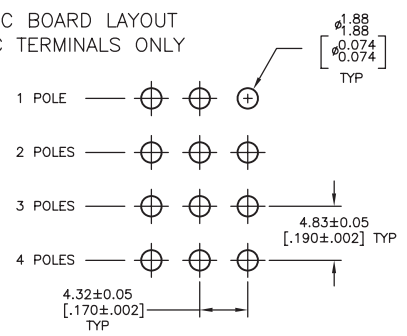

**MP / A / E / G, Green Series (Continued)**

**Bushing style E**



**single & double pole**



MPE106D



MPE206N

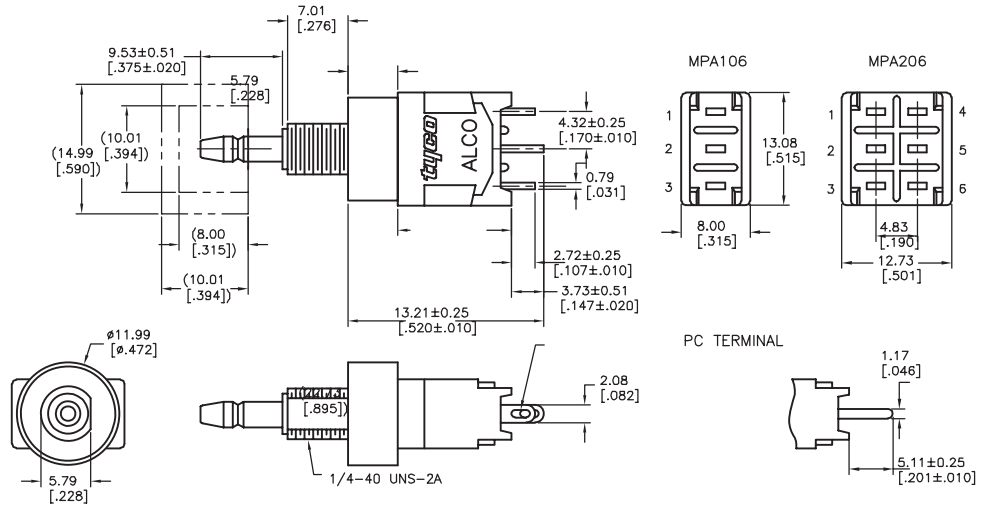

**3 & 4 pole**



MPE306F



MPE406N

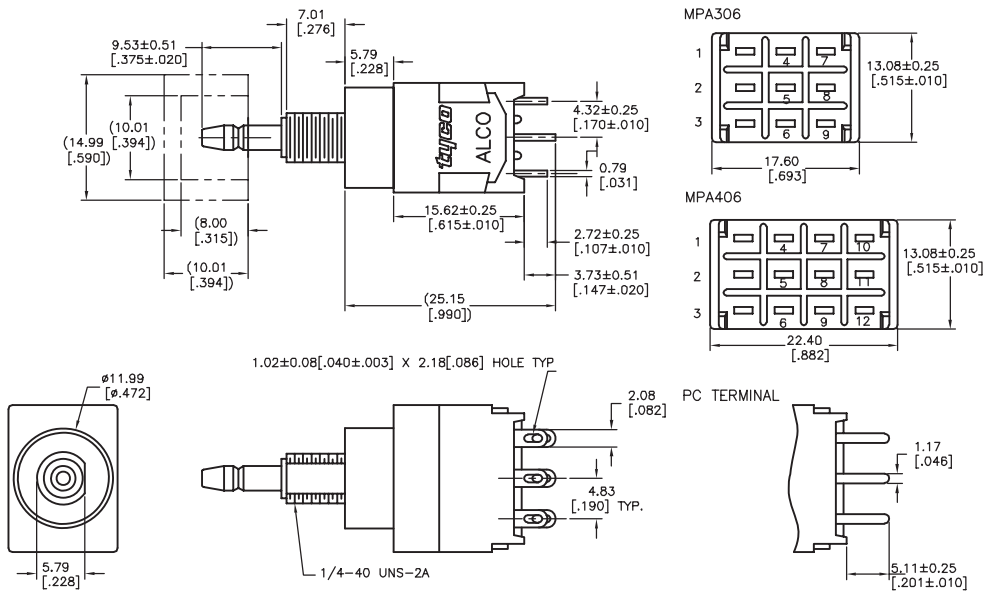

**mounting**

**RECOMMENDED HOLE LAYOUT TO PREVENT ROTATION**

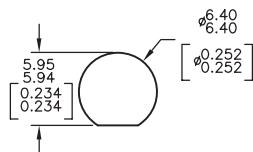

**PC BOARD LAYOUT PC TERMINALS ONLY**

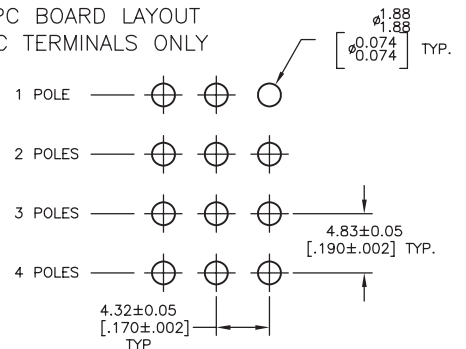

**MP / A / E / G, Green Series (Continued)**

Bushing style G

single & double pole



MPG106D



MPG206NPC

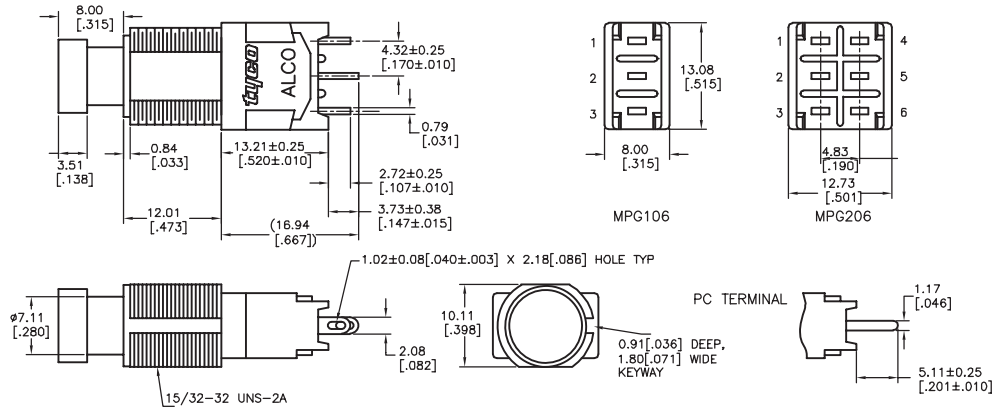

3 & 4 pole



MPG306D



MPG406N

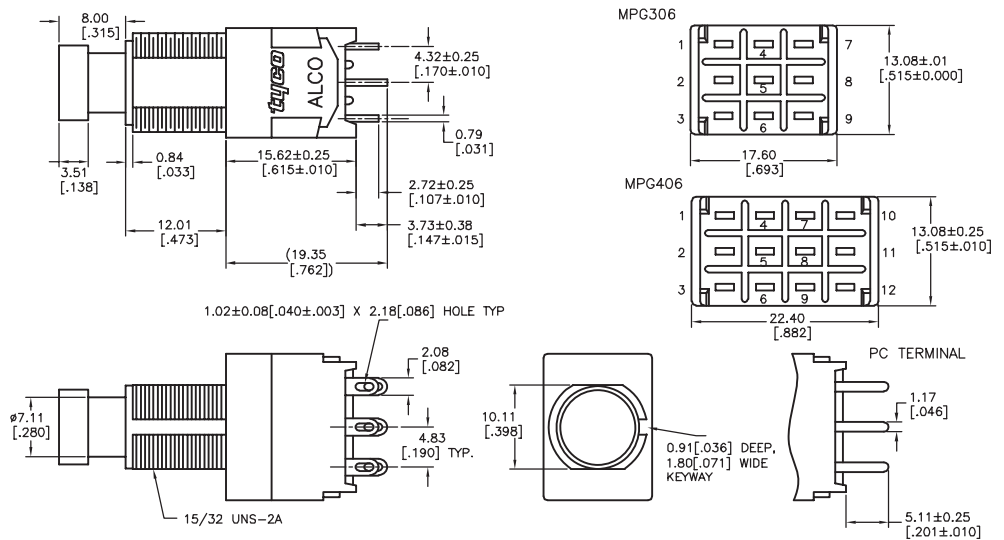

mounting

RECOMMENDED HOLE LAYOUT TO PREVENT ROTATION

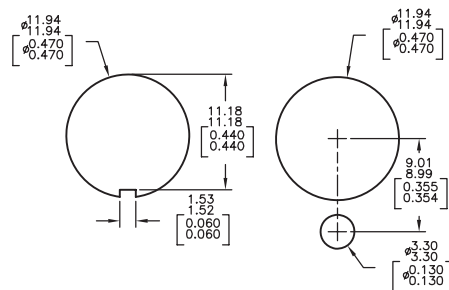



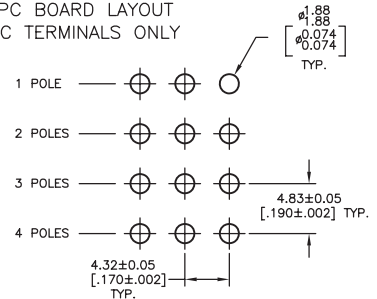

PC BOARD LAYOUT PC TERMINALS ONLY



**MP / A / E / G, Green Series** (Continued)

Function 

Fct.	Poles				
D	1	On	On	2-1	2-3
F	1	On	(On)	2-1	2-3
N	2	On	On	2-1, 5-4	2-3, 5-6
R	2	On	(On)	2-1, 5-4	2-3, 5-6
D	3	On	On	2-1, 5-4, 8-7	2-3, 5-6, 8-9
F	3	On	(On)	2-1, 5-4, 8-7	2-3, 5-6, 8-9
N	4	On	On	2-1,5-4,8-7,11-10	2-3,5-6,8-9,11-12
R	4	On	(On)	2-1,5-4,8-7,11-10	2-3,5-6,8-9,11-12

Off indicates a mechanical position with no electrical connection  
(On) indicates momentary connection

Pushbutton Switches

Product key	Bushing	No. of poles	Rating	Function	Terminals	Material	Part Number
<b>MPA106D04</b>	1/4-40	single pole	6 Amps	push-on/push-off	wire lug	RoHS compliant	<b>1825040-1</b>
<b>MPA106F04</b>	3.4mm			momentary			<b>1825040-2</b>
<b>MPA106DPC04</b>	actuator			push-on/push-off	pcb		<b>1825040-3</b>
<b>MPA106FPC04</b>				momentary			<b>1825040-4</b>
<b>MPA206N04</b>		double pole		push-on/push-off	wire lug		<b>1825040-5</b>
<b>MPA206NPC04</b>					pcb		<b>1825040-6</b>
<b>MPA206R04</b>				momentary	wire lug		<b>1825040-7</b>
<b>MPA206RPC04</b>					pcb		<b>1825040-8</b>
<b>MPA306D04</b>		3 poles		push-on/push-off	wire lug		<b>1825040-9</b>
<b>MPA306F04</b>				momentary			<b>1-1825040-0</b>
<b>MPA406N04</b>		4 poles		push-on/push-off			<b>1-1825040-1</b>
<b>MPA406R04</b>				momentary			<b>1-1825040-2</b>
<b>MPE106D04</b>	1/4-40	single pole		push-on/push-off			<b>1825041-1</b>
<b>MPE106F04</b>	3.4mm			momentary			<b>1825041-2</b>
<b>MPE206N04</b>	actuator	double pole		push-on/push-off			<b>1825041-3</b>
<b>MPE206R04</b>	with 'O' ring			momentary			<b>1825041-4</b>
<b>MPE306D04</b>		3 poles		push-on/push-off			<b>1825041-5</b>
<b>MPE306F04</b>				momentary			<b>1825041-6</b>
<b>MPE406N04</b>		4 poles		push-on/push-off			<b>1825041-7</b>
<b>MPE406R04</b>				momentary			<b>1825041-8</b>
<b>MPG106D04</b>	15/32-32	single pole		push-on/push-off			<b>1825042-1</b>
MPG106DPC04	large			push-on/push-off	pcb		1825042-2
<b>MPG106F04</b>	actuator			momentary	wire lug		<b>1825042-3</b>
MPG106FPC04					pcb		1825042-4
<b>MPG206N04</b>		double pole		push-on/push-off	wire lug		<b>1825042-5</b>
<b>MPG206NPC04</b>					pcb		<b>1825042-6</b>
<b>MPG206R04</b>				momentary	wire lug		<b>1825042-7</b>
<b>MPG206RPC04</b>					pcb		<b>1825042-8</b>
<b>MPG306D04</b>		3 poles		push-on/push-off	wire lug		<b>1825042-9</b>
<b>MPG306F04</b>				momentary			<b>1-1825042-0</b>
<b>MPG406N04</b>		4 poles		push-on/push-off			<b>1-1825042-1</b>
<b>MPG406R04</b>				momentary			<b>1-1825042-2</b>

Preferred parts in bold print